



Click! Surplus Declaration

City of Tacoma | Tacoma Public Utility Board

Joint Study Session
October 22, 2019
Item No. One



180 Count Backbone Fiber

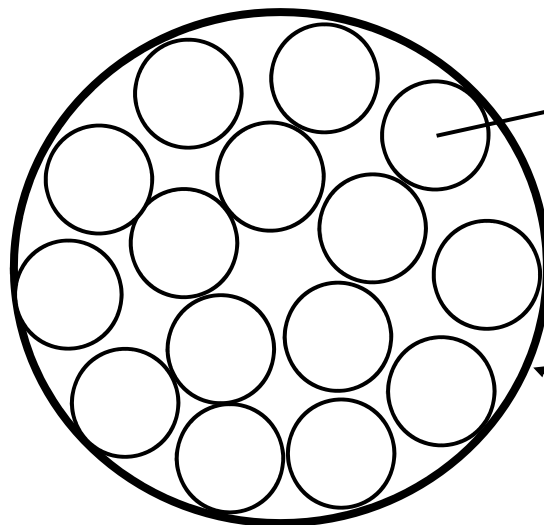

12 Fibers

15 Tubes

180 Count Backbone Fiber

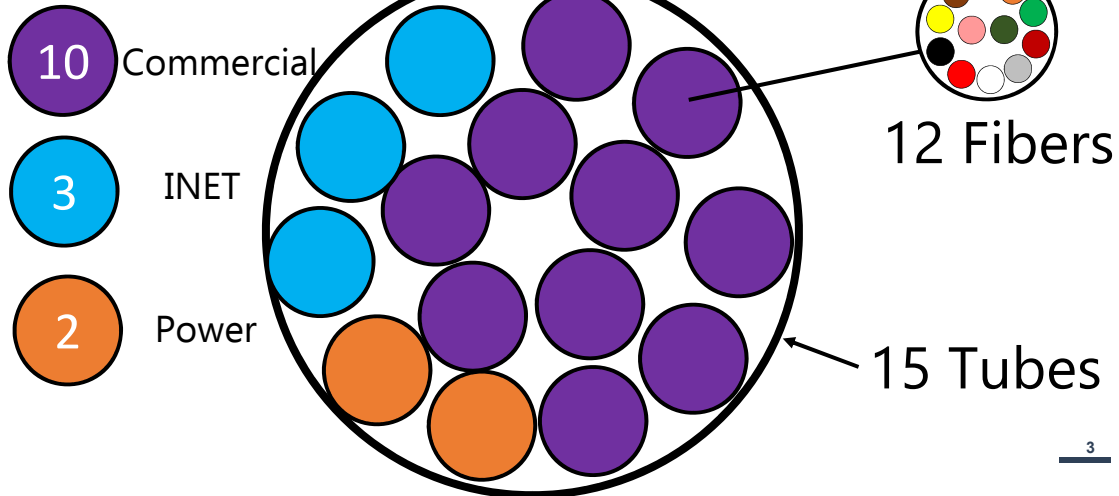

Surplus declaration of the Commercial Network (purple) only.

The Network Layout

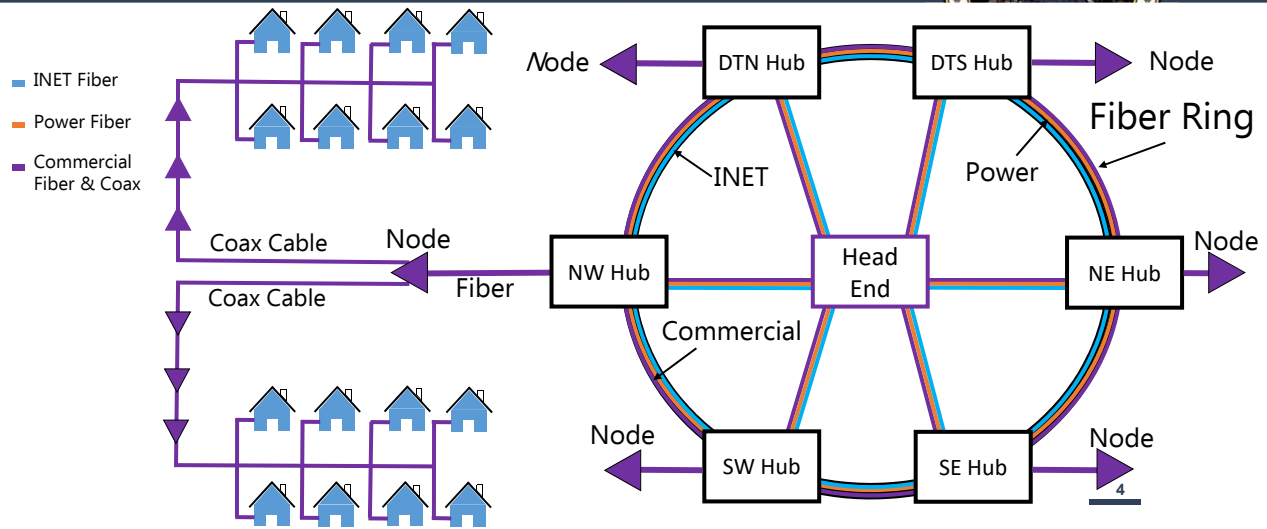

Surplus declaration of the Commercial Network (purple) only.

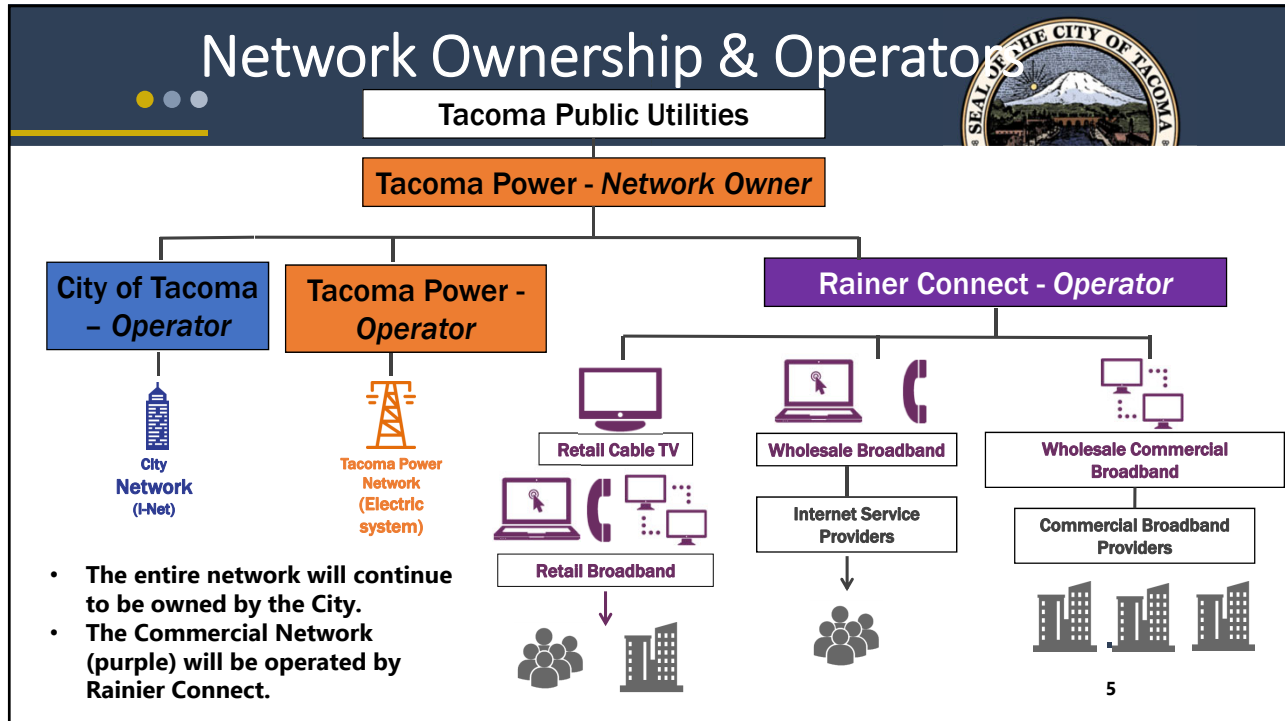

Surplus Declaration



THE SURPLUS PROPERTY DECLARATION

6

Surplused Assets



What assets of Tacoma Power will be declared surplus?

- Inventory, equipment and vehicles used by Click! that will be conveyed to Rainier Connect
- Excess Capacity of the HFC Network

7

Proposed Disposal



What methods of disposal are proposed in the contract documents?

- Inventory, equipment and vehicles: Title is proposed to be conveyed to Rainier Connect in consideration for contract obligations and value assigned to certain property.
- Excess Capacity of HFC Network: Operational rights proposed to be transferred pursuant to the terms of the indefeasible right of use agreement for a term of 20 years with two additional 10 year extensions.
- Ownership: City will retain ownership of the Excess Capacity

8

EXCESS CAPACITY



What is “Excess Capacity of the HFC Network”?

- The capacity of the HFC Network, together with electronic equipment and related hardware installed in the HUB site and in rights of way, that is **not reserved** for use by Tacoma Power or the Institutional Network.
- This includes the portion of the HFC Network being used by Click! Network to provide Cable, wholesale broadband and metro ethernet services together with dark fiber (unlit or unused) on the HFC Network

9

Why



Why is it necessary to surplus the Excess Capacity of the HFC Network if the City will not be selling the Excess Capacity to Rainer Connect?

- A surplus declaration is advised because state law could be construed as requiring such a declaration prior to leasing any property acquired for public utility purposes, including granting an indefeasible right of use to Rainier Connect over the Excess Capacity of the HFC Network.
- RCW 35.94.040 establishes a process for declaring utility property surplus prior to leasing such property

10

● ● ● Meaning of Surplus



What does “surplus” mean?

- State law does not define this term in the statute (RCW Ch. 35.94). When state law does not define a term, its ordinary meaning can be used to interpret that term.
- Merriam-Webster and Dictionary.Com respectively define “surplus” to mean:
 - ✓ “the amount that remains when use or need is satisfied”.
 - ✓ “something that remains above what is used or needed”.

11

● ● ● Effect of Surplus Declaration



What is the effect of declaring the Excess Capacity of the HFC Network surplus to the utility?

- Declaring property surplus means that the property can be disposed of by sale, lease or other method of disposal.
- Declaring property surplus does not mean that it must be disposed immediately.

12

Operation in transition



Who will operate Click! if the surplus declaration is approved by the City Council and TPU Board?

- Tacoma Power will continue to operate the Click! Network until the Board and City Council approve of a method of disposal, i.e. the Click! Business Transaction Agreement.
- If the proposed agreement is approved, Tacoma Power will continue to operate the Click! Network until transfer of operational control occurs which is contemplated to be between 90 - 120 days following execution of the Click! Business Transaction Agreement.

13

When will Disposal Occur



When will the Excess Capacity of the HFC Network and the surplused inventory, equipment and vehicles be disposed of?

- This would not take place until the conditions precedent to the Transfer of Operational Control occurs (90 – 120 days).
- At that time, the Indefeasible Right of Use Agreement would be executed and Rainier Connect would take over operational control of the Excess Capacity of the HFC Network and ownership of the inventory, equipment and vehicles.

14



Click! Surplus Declaration

City of Tacoma | Tacoma Public Utility Board

Joint Study Session
October 22, 2019
Item No. One



Update & Analysis:
Incorporation of Click! Policy
Goals into IRU & Click! Business
Transaction Agreement

Presented by Joanne Hovis
to the City of Tacoma City Council
& Utility Board
October, 22 2019

Background

Click! History and Analysis

15 year track record of policy success

Led to multi-year investigation of future path

Thorough investigation led to development of 12 Click! policy goals, reflecting the areas of success to-date and the criteria for decision-making for the future

Policy goals adopted by Council and Board in 2018 became framework for evaluating future strategies

3

The 12 Click! Policy Goals

Public ownership of assets

Equitable access

Low-income/affordable access

Net neutrality

Open access by other providers

Preserve competition

Safeguard municipal use of services

Maintain financial stability

Economic development & educational opportunities

Job options for Click! staff

Consumer privacy

Click! goodwill, customer service

4

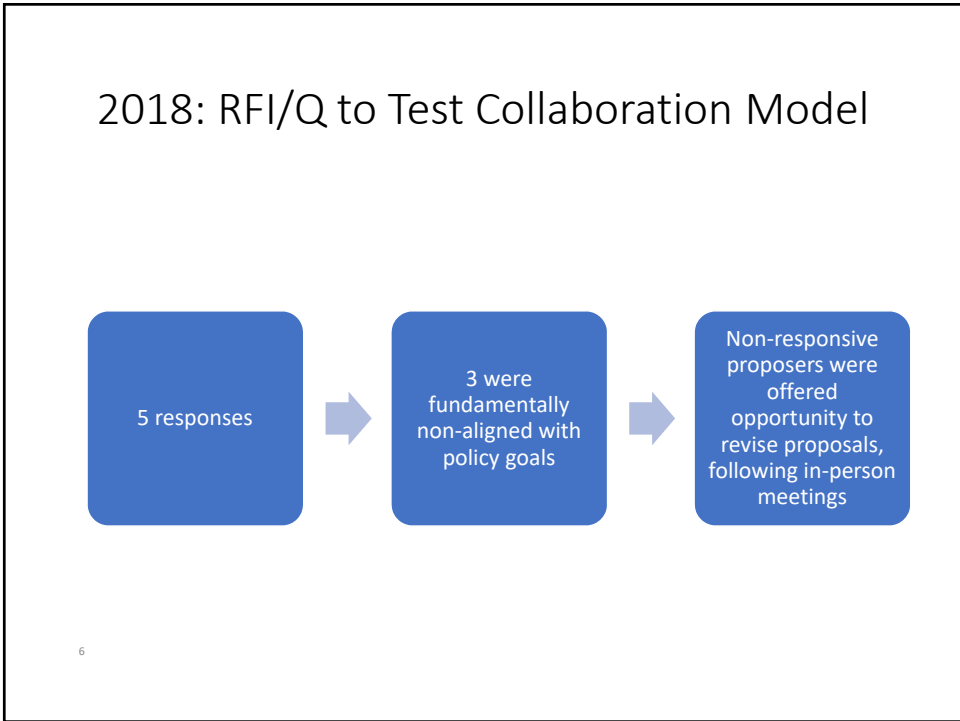
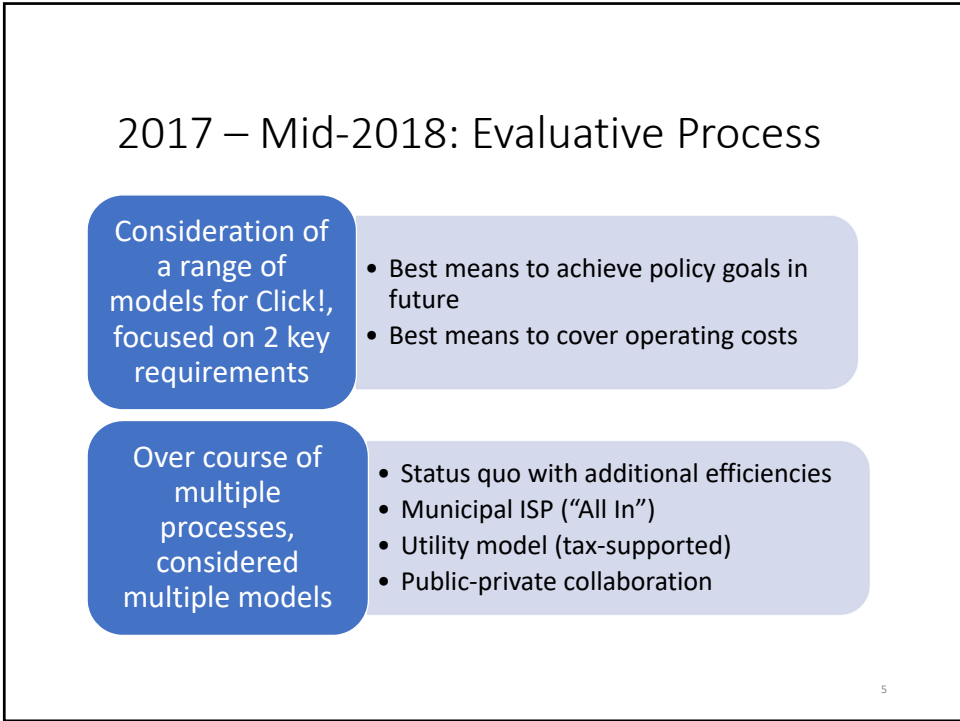

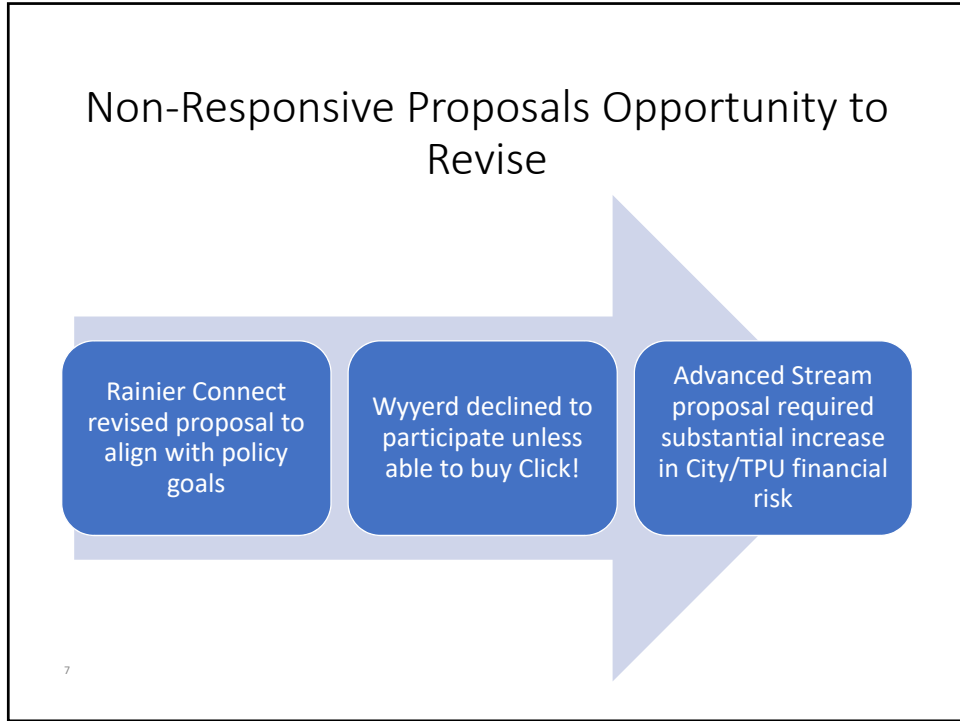

Fall 2018

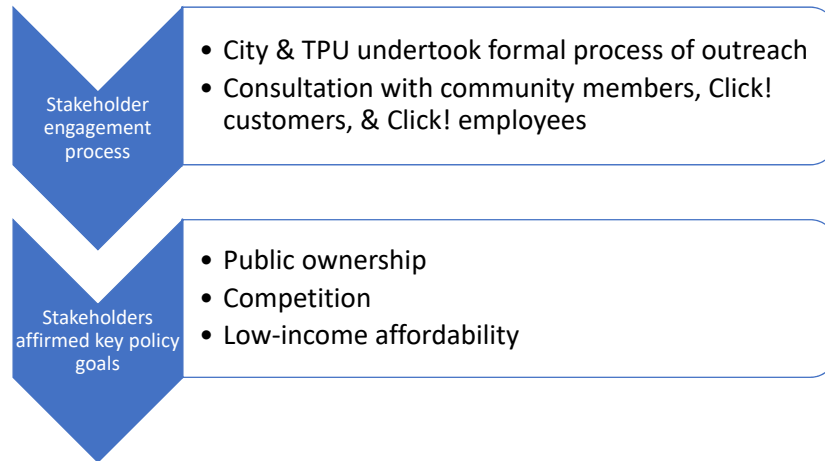

9

Fall 2018 – March 2019

Negotiations with three final respondents

- **Yomura Fiber:** Promising discussions ended due to incompatibility regarding control of fiber to meet power utility security regulations
- **Wave Broadband:** Extensive discussions lead to completed term sheet
- **Rainier Connect:** Extensive discussions lead to completed term sheet

10

March 2019 – Present

Negotiations with Rainier Connect

- Rainier Connect selected to move forward
- Extensive discussions lead to completed draft agreements & exhibits
- Click! Business Transaction Agreement
- Indefeasible Right of Use Agreement

11

POLICY GOALS INCORPORATED
INTO AGREEMENTS & exhibits

1. Public Ownership of Assets

Term: 20-year term with 2 potential 10-year renewals

Network upgrade: Cable broadband state-of-the-art (gigabit) within 3 years

Network upgrades over time: Rainier to keep parity with cable broadband providers in the region

Assets: New assets constructed, replaced, or upgraded by Rainier become TPU property within IRU term

13

2. Equitable Access

Like services at like prices: Rainier will offer the same services -- at the same prices -- to the whole community

Ubiquitous upgrades: Rainier will upgrade the network to all, not just a few

Equitable access to service: Rainier may not decline service to any customer in good standing & will purposefully endeavor to increase access

14

3. Low-Income/Affordable Access

Federal subsidy: Rainier commits to provide the federal Lifeline subsidy to customers that qualify

High quality inclusion product: Rainier will offer reduced-cost broadband to households eligible for TPU's electric service low-income program

Free access to community anchors: Rainier will provide free internet access to 30 locations

15

4. Net Neutrality

Transparency: Rainier will fully & publicly disclose accurate information about its services

No throttling: Rainier will not impair or degrade lawful Internet traffic based on content

No blocking: Rainier will not block lawful content, websites, resources, applications, services, or non-harmful devices

No discrimination: Rainier will treat all lawful traffic similarly

No paid prioritization: Rainier will not treat some Internet traffic better for financial reasons

Verification: TPU can test

16

5. Open Access

Open Access Program: Rainier Connect commits to provide wholesale services to other providers consistent with Rainier's practices & policies in other areas

Verification: Negotiation team verified that the company does provide wholesale services in other markets

17

6. Preserve Competition

No transfer without TPU consent: TPU prior consent required for Rainier to transfer its IRU rights (including changes in control of Rainier)

No transfer that would reduce local competition: Rainier may not transfer its IRU rights to any company that already has 25% residential market share

Transferee must commit to 12 policy goals: TPU can reject a transfer that violates any of the 12 policy goals

18

7. Safeguard Municipal Use of Services

TPU controls fiber: TPU will maintain control of all fiber maintenance on Critical Routes that serve utility and municipal purposes

TPU eliminates cost of maintenance on non-critical routes: Rainier will be responsible for maintenance of coaxial infrastructure

Technical safeguards: The contract includes multiple means by which TPU maintains control and security of assets that serve critical municipal needs

19

8. Maintain Financial Stability

Annual IRU Fee: Rainier will pay TPU for use of the network \$2.5M in year 1, growing to \$3M in year 5 and then growing by rate of inflation

Network investment: Rainier will invest at least \$1.5M in the network per year, growing by rate of inflation

Verification: TPU can audit capital expenditures every 3 years

20

9. Economic Development & Educational Opportunities

Training: Rainier Connect will create an internship program for students & residents

Business attraction: Rainier will work with TPU to support efforts to attract businesses to Tacoma

21

10. Job Options for Click! Staff

Rainier commits to make good faith effort to consider existing Click! employees when filling vacancies

22

11. Consumer Privacy

Compliance with City privacy policy: Rainier commits to comply with City Council Resolution No. 39702 & implement it into its own broadband data service

Ensure ISP compliance: Rainier will require the same policies of any ISPs that buy its wholesale service

Transparent privacy policy: Rainier commits to publish the privacy policy on its website so its practices are open and transparent to the public

23

12. Click! Goodwill & Customer Service

Responsiveness: Rainier will maintain a local or toll-free telephone line for taking customer calls

Speedy response: Customer contacts will be answered within 30 seconds & repairs started within 24 hrs.

Reasonable service timing: Rainier will schedule during four-hour time blocks & begin installations within 7-days

Notice: Rainier will provide 30 days' notice for changes in rates or services

Localism: Rainier will have staff in Tacoma

24